



Baldhead Price List and Specification Sheet

V4.1.2009

Welcome to Baldhead Cabinet Company

Thank you for the opportunity to share information with you on what we feel are the best metal cabinets in the business. Enclosed, you will find details on an extensive variety of sizes and module types, allowing you to design the perfect layout for a garage or shop. Baldhead Cabinet Company manufactures all of our cabinets in the USA with an ongoing commitment to offer clients the highest quality available.

Please call or e-mail us if you have any questions or would like to discuss your particular requirements.

Eric Fleming
President
Baldhead Cabinet Company
www.baldheadcabinets.com

Ordering Information



#H = Pull Handle



#P = Pocket Handle

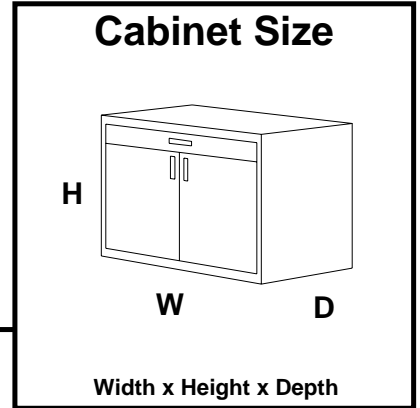

#H-7D363224-M-BLKRED

Cabinet Type

- Workbench Drawer Units
- Workbench Upper Units
- Corner Units
- Tall Storage Units

**Finish Type
(Powder Coated)**

- M = Fine Texture Matte
- G = Rough Texture Glossy

**Cabinet Color
(Cabinet Shell / Doors & Drawers)**

- BLKRED = Black/Red
- BLKCRM = Black/Cream
- BLKBLU = Black/Blue
- BLKYLW = Black/Yellow
- BLKWHT = Black/White
- BLKGRY = Black/Gray
- BLKBLK = Black/Black
- BLKTAN = Black/Tan
- BLKSS = Black/Stainless*

*Upcharge applies

Workbench Height Base Cabinets

Part Number #	Width	Height	Depth	Weight	Price \$
---------------	-------	--------	-------	--------	----------

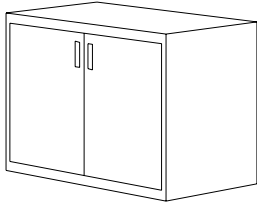

Storage Unit

- (1) RH or LH Door Operation
or
- (1) Set of Doors
- Includes (1) Shelf

#S243224RH	23.63"	31.50"	23.63"	140lbs	\$629.00
#S243224LH	23.63"	31.50"	23.63"	140lbs	\$629.00
#S303224	29.53"	31.50"	23.63"	160lbs	\$729.00
#S363224	35.43"	31.50"	23.63"	180lbs	\$829.00
#S483224	47.23"	31.50"	23.63"	220lbs	\$929.00

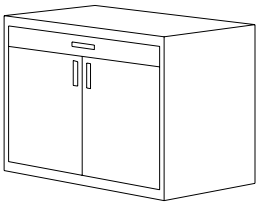

One Drawer Unit

- (1) 5.00" Drawer
- (1) RH or LH Door operation
or
- (1) Set of Doors
- Includes (1) Shelf
- Includes (1) Non-Slip Liner

#1D243224RH	23.63"	31.50"	23.63"	150lbs	\$729.00
#1D243224LH	23.63"	31.50"	23.63"	150lbs	\$729.00
#1D303224	29.53"	31.50"	23.63"	170lbs	\$829.00
#1D363224	35.43"	31.50"	23.63"	190lbs	\$929.00

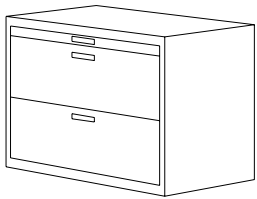

Three Drawer Unit

- (1) 2.50" Drawer
- (2) 12.50" Deep File Drawers
- Includes (3) Non-Slip Liners

#3D243224	23.63"	31.50"	23.63"	180lbs	\$929.00
#3D303224	29.53"	31.50"	23.63"	205lbs	\$1,029.00
#3D363224	35.43"	31.50"	23.63"	230lbs	\$1,129.00



Five Drawer Unit

- (1) 2.50" Drawer
- (2) 5.00" Deep Drawers
- (2) 7.50" Deep Drawers
- Includes (5) Non-Slip Liners

#5D243224	23.63"	31.50"	23.63"	200lbs	\$1,129.00
#5D303224	29.53"	31.50"	23.63"	230lbs	\$1,229.00
#5D363224	35.43"	31.50"	23.63"	260lbs	\$1,329.00

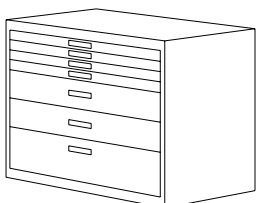

Seven Drawer Unit

- (4) 2.50" Drawer
- (2) 5.00" Deep Drawers
- (1) 7.50" Deep Drawers
- Includes (7) Non-Slip Liners

#7D243224	23.63"	31.50"	23.63"	220lbs	\$1,249.00
#7D303224	29.53"	31.50"	23.63"	255lbs	\$1,349.00
#7D363224	35.43"	31.50"	23.63"	290lbs	\$1,449.00

Workbench Height Base Cabinets

Part Number #	Width	Height	Depth	Weight	Price \$
---------------	-------	--------	-------	--------	----------

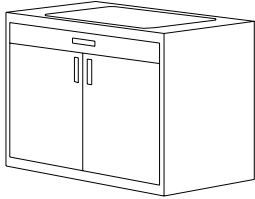

Sink Unit

- (1) 5.00" Stationary False Front
- (1) RH or LH Door or Set of Doors
- Open back and Top cut out for Sink

#SK243224RH	23.63"	31.50"	23.63"	130lbs	\$619.00
#SK243224LH	23.63"	31.50"	23.63"	130lbs	\$619.00
#SK303224	29.53"	31.50"	23.63"	150lbs	\$699.00
#SK363224	35.43"	31.50"	23.63"	170lbs	\$779.00
#SK483224	47.23"	31.50"	23.63"	190lbs	\$879.00

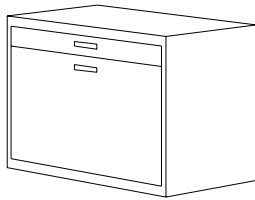

Utility Sports Drawer Unit

- (1) 5.00" Drawer
- (1) 22.50" Deep Drawer
- Includes (1) Non-Slip Liner

#US243224	23.63"	31.50"	23.63"	190lbs	\$829.00
#US303224	29.53"	31.50"	23.63"	220lbs	\$899.00
#US363224	35.43"	31.50"	23.63"	240lbs	\$979.00

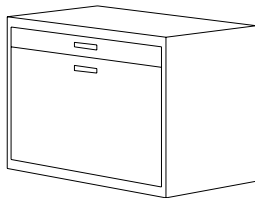

Pet Food Unit

- (1) 5.00" Drawer
- (1) Drawer with Sealed Plastic Container for Pet Food or Cat Litter
- Includes (1) Non-Slip Liner

#PF243224	23.63"	31.50"	23.63"	200lbs	\$929.00
#PF303224	29.53"	31.50"	23.63"	225lbs	\$1,049.00
#PF363224	35.43"	31.50"	23.63"	250lbs	\$1,179.00

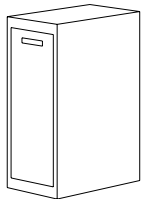

Pull-Out Fastener Unit

- Includes (24) or (48) Plastic Bins for Fasteners or Small parts

#PO123224	11.81"	31.50"	23.63"	120lbs	\$679.00
#PO243224	23.63"	31.50"	23.63"	180lbs	\$979.00

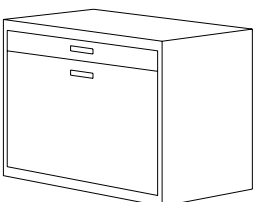

Trash Can Unit

- (1) 5.00" Drawer
- (1) Plastic Cans or
- (2) Plastic Cans (Black & Blue)
- Includes (1) Non-Slip Liner

#TC243224	23.63"	31.50"	23.63"	200lbs	\$929.00
#TC303224	29.53"	31.50"	23.63"	225lbs	\$1,029.00
#TC363224	35.43"	31.50"	23.63"	250lbs	\$1,129.00

Workbench Upper Cabinets - Shallow

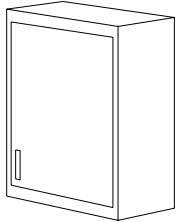

Workbench 24" Wide Upper Unit

- (1) RH or LH Door Operation
- (1) Shelf on 26.46" & 31.50" tall
- (2) Shelves on 44.09" & 50.39" tall

Part Number #	Width	Height	Depth	Weight	Price \$
---------------	-------	--------	-------	--------	----------

#SU241914RH	23.63"	18.90"	13.78"	80lbs	\$349.00
#SU241914LH	23.63"	18.90"	13.78"	80lbs	\$349.00
#SU242414RH	23.63"	23.94"	13.78"	90lbs	\$399.00
#SU242414LH	23.63"	23.94"	13.78"	90lbs	\$399.00
#SU242714RH	23.63"	26.46"	13.78"	95lbs	\$449.00
#SU242714LH	23.63"	26.46"	13.78"	95lbs	\$449.00
#SU243214RH	23.63"	31.50"	13.78"	100lbs	\$499.00
#SU243214LH	23.63"	31.50"	13.78"	100lbs	\$499.00
#SU244514RH	23.63"	44.09"	13.78"	130lbs	\$649.00
#SU244514LH	23.63"	44.09"	13.78"	130lbs	\$649.00
#SU245114RH	23.63"	50.39"	13.78"	150lbs	\$799.00
#SU245114LH	23.63"	50.39"	13.78"	150lbs	\$799.00

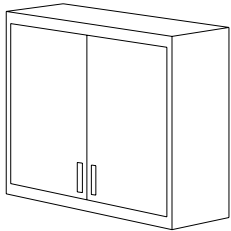

Workbench 30" Wide Upper Unit

- (1) Set of Doors
- (1) Shelf on 26.46" & 31.50" tall
- (2) Shelves on 44.09" & 50.39" tall

#SU301914	29.53"	18.90"	13.78"	90lbs	\$449.00
#SU302414	29.53"	23.94"	13.78"	100lbs	\$499.00
#SU302714	29.53"	26.46"	13.78"	110lbs	\$549.00
#SU303214	29.53"	31.50"	13.78"	120lbs	\$599.00
#SU304514	29.53"	44.09"	13.78"	155lbs	\$749.00
#SU305114	29.53"	50.39"	13.78"	180lbs	\$899.00

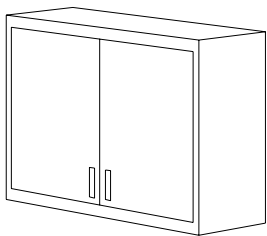

Workbench 36" Wide Upper Unit

- (1) Set of Doors
- (1) Shelf on 26.46" & 31.50" tall
- (2) Shelves on 44.09" & 50.39" tall

#SU361914	35.43"	18.90"	13.78"	100lbs	\$549.00
#SU362414	35.43"	23.94"	13.78"	110lbs	\$599.00
#SU362714	35.43"	26.46"	13.78"	125lbs	\$649.00
#SU363214	35.43"	31.50"	13.78"	140lbs	\$699.00
#SU364514	35.43"	44.09"	13.78"	180lbs	\$849.00
#SU365114	35.43"	50.39"	13.78"	210lbs	\$999.00

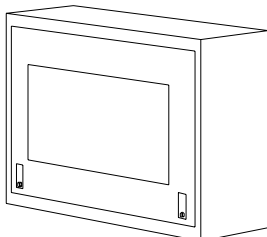

Flat Screen Upper Unit

- Open Back to allow for outlets on the wall
- Complete with Thermostat, Fan, and Plug Strip
- Flat Screen sold separately

#TV363214	35.43"	31.50"	13.78"	130lbs	\$1,149.00
#TV364514	35.43"	44.09"	13.78"	170lbs	\$1,249.00
#TV483214	47.23"	31.50"	13.78"	150lbs	\$1,349.00
#TV484514	47.23"	44.09"	13.78"	180lbs	\$1,449.00

Workbench Upper Glass Door Cabinets - Shallow

Part Number #	Width	Height	Depth	Weight	Price \$
---------------	-------	--------	-------	--------	----------

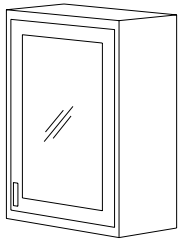

Workbench 24" Wide Glass Upper Unit

- (1) RH or LH Door Operation
 - (1) Shelf on 26.46" & 31.50" tall
 - (2) Shelves on 44.09" & 50.39" tall
- Tempered Glass

#GU242414RH	23.63"	23.94"	13.78"	90lbs	\$499.00
#GU242414LH	23.63"	23.94"	13.78"	90lbs	\$499.00
#GU242714RH	23.63"	26.46"	13.78"	95lbs	\$549.00
#GU242714LH	23.63"	26.46"	13.78"	95lbs	\$549.00
#GU243214RH	23.63"	31.50"	13.78"	100lbs	\$599.00
#GU243214LH	23.63"	31.50"	13.78"	100lbs	\$599.00
#GU244514RH	23.63"	44.09"	13.78"	130lbs	\$749.00
#GU244514LH	23.63"	44.09"	13.78"	130lbs	\$749.00
#GU245114RH	23.63"	50.39"	13.78"	150lbs	\$899.00
#GU245114LH	23.63"	50.39"	13.78"	150lbs	\$899.00

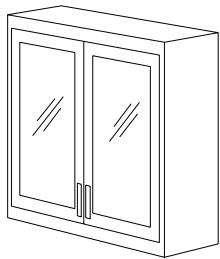

Workbench 30" Wide Glass Upper Unit

- (1) Set of Doors
 - (1) Shelf on 26.46" & 31.50" tall
 - (2) Shelves on 44.09" & 50.39" tall
- Tempered Glass

#GU302414	29.53"	23.94"	13.78"	100lbs	\$599.00
#GU302714	29.53"	26.46"	13.78"	110lbs	\$649.00
#GU303214	29.53"	31.50"	13.78"	120lbs	\$699.00
#GU304514	29.53"	44.09"	13.78"	155lbs	\$849.00
#GU305114	29.53"	50.39"	13.78"	180lbs	\$999.00

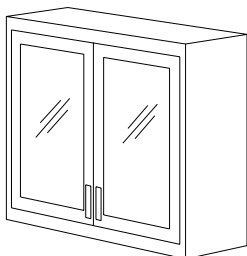

Workbench 36" Wide Glass Upper Unit

- (1) Set of Doors
 - (1) Shelf on 26.46" & 31.50" tall
 - (2) Shelves on 44.09" & 50.39" tall
- Tempered Glass

#GU362414	35.43"	23.94"	13.78"	110lbs	\$699.00
#GU362714	35.43"	26.46"	13.78"	125lbs	\$749.00
#GU363214	35.43"	31.50"	13.78"	140lbs	\$799.00
#GU364514	35.43"	44.09"	13.78"	180lbs	\$949.00
#GU365114	35.43"	50.39"	13.78"	210lbs	\$1,099.00

Corner Blind Cabinets

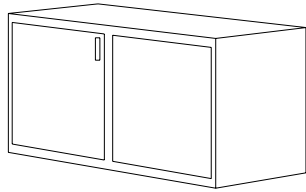

Left Hand Shown

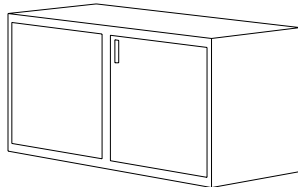

Right Hand Shown

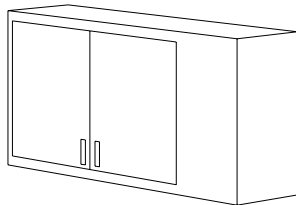

Left Hand Shown

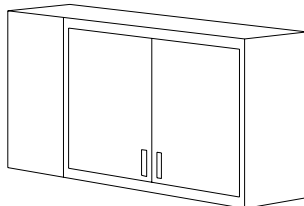

Right Hand Shown

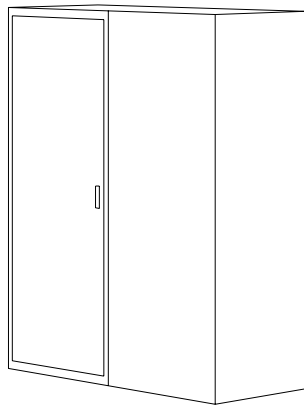

Left Hand Shown

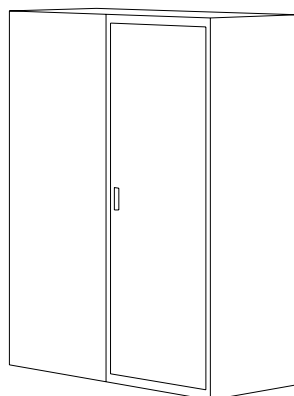

Right Hand Shown

Part Number #	Width	Height	Depth	Weight	Price \$
---------------	-------	--------	-------	--------	----------

#CB483224LH	47.23"	31.50"	23.63"	210lbs	\$1,029.00
#CB483224RH	47.23"	31.50"	23.63"	210lbs	\$1,029.00

Workbench Lower Blind Corner

Includes (1) Shelf

#CBU482414LH	47.23"	23.94"	13.78"	140lbs	\$779.00
#CBU482414RH	47.23"	23.94"	13.78"	140lbs	\$779.00
#CBU482714LH	47.23"	26.46"	13.78"	150lbs	\$879.00
#CBU482714RH	47.23"	26.46"	13.78"	150lbs	\$879.00
#CBU483214LH	47.23"	31.50"	13.78"	160lbs	\$979.00
#CBU483214RH	47.23"	31.50"	13.78"	160lbs	\$979.00
#CBU484514LH	47.23"	44.09"	13.78"	200lbs	\$1,179.00
#CBU484514RH	47.23"	44.09"	13.78"	200lbs	\$1,179.00
#CBU485114LH	47.23"	50.39"	13.78"	230lbs	\$1,279.00
#CBU485114RH	47.23"	50.39"	13.78"	230lbs	\$1,279.00

Workbench Upper Blind Corner

- (1) Shelf on 26.46" & 31.50" tall
- (2) Shelves on 44.09" and 50.39" tall

#CB485124LH	47.23"	50.39"	23.63"	375lbs	\$1,349.00
#CB485124RH	47.23"	50.39"	23.63"	375lbs	\$1,349.00
#CB487224LH	47.23"	71.81"	23.63"	425lbs	\$1,449.00
#CB487224RH	47.23"	71.81"	23.63"	425lbs	\$1,449.00
#CB488224LH	47.23"	81.89"	23.63"	500lbs	\$1,549.00
#CB488224RH	47.23"	81.89"	23.63"	500lbs	\$1,549.00

Tall Blind Corner Unit

- (2) Shelves on 59.39" tall
- (3) Shelves on 71.81" tall
- (4) Shelves on 81.89" tall

45 Degree Corner Cabinets

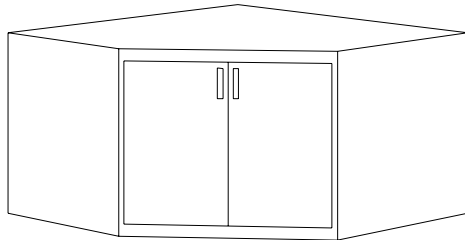

Part Number #	Width	Height	Depth	Weight	Price \$
---------------	-------	--------	-------	--------	----------

#C483248	47.23"	31.50"	47.23"	200lbs	\$1,479.00
----------	--------	--------	--------	--------	------------

Workbench Lower Corner Unit

Includes (1) Shelf

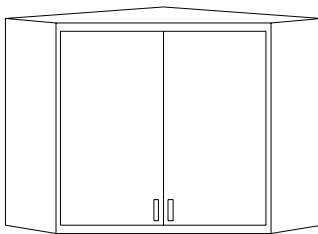

#CU242424RH	23.63"	23.94"	23.63"	100lbs	\$699.00
#CU242424LH	23.63"	23.94"	23.63"	100lbs	\$699.00
#CU242724RH	23.63"	26.46"	23.63"	110lbs	\$749.00
#CU242724LH	23.63"	26.46"	23.63"	110lbs	\$749.00
#CU243224RH	23.63"	31.50"	23.63"	120lbs	\$799.00
#CU243224LH	23.63"	31.50"	23.63"	120lbs	\$799.00
#CU244524RH	23.63"	44.09"	23.63"	145lbs	\$899.00
#CU244524LH	23.63"	44.09"	23.63"	145lbs	\$899.00
#CU302430	29.53"	23.94"	29.53"	120lbs	\$799.00
#CU302730	29.53"	26.46"	29.53"	130lbs	\$849.00
#CU303230	29.53"	31.50"	29.53"	140lbs	\$899.00
#CU304530	29.53"	44.09"	29.53"	155lbs	\$999.00
#CU305130	29.53"	50.39"	29.53"	165lbs	\$1,099.00
#CU362426	35.43"	23.94"	35.43"	140lbs	\$899.00
#CU362736	35.43"	26.46"	35.43"	150lbs	\$949.00
#CU363236	35.43"	31.50"	35.43"	160lbs	\$999.00
#CU364536	35.43"	44.09"	35.43"	175lbs	\$1,099.00
#CU365136	35.43"	50.39"	35.43"	185lbs	\$1,199.00

Workbench Upper Corner Unit

- (1) Shelf on 26.46" & 31.50" tall
- (2) Shelves on 44.09" & 50.39" tall

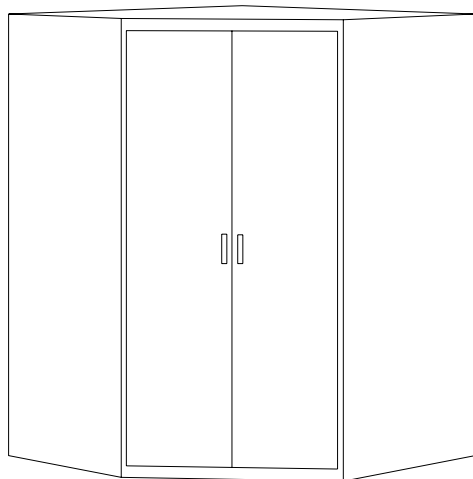

#C485148	47.23"	50.39"	47.23"	450lbs	\$1,699.00
#C487248	47.23"	71.81"	47.23"	525lbs	\$1,999.00
#C488248	47.23"	81.89"	47.23"	600lbs	\$2,499.00

Tall Corner Unit

- (2) Shelves on 50.39" tall
- (3) Shelves on 71.81" tall
- (4) Shelves on 81.89" tall

Tall Storage Cabinets

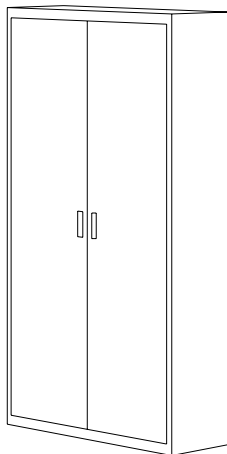

Part Number #	Width	Height	Depth	Weight	Price \$
---------------	-------	--------	-------	--------	----------

#S247214LH	23.63"	71.81"	13.78"	220lbs	\$929.00
#S247214RH	23.63"	71.81"	13.78"	200lbs	\$929.00
#S248214LH	23.63"	81.89"	13.78"	230lbs	\$1,029.00
#S248214RH	23.63"	81.89"	13.78"	230lbs	\$1,029.00
#S307214	29.53"	71.81"	13.78"	235lbs	\$1,079.00
#S308214	29.53"	81.89"	13.78"	265lbs	\$1,179.00
#S367214	35.43"	71.81"	13.78"	265lbs	\$1,229.00
#S368214	35.43"	81.89"	13.78"	300lbs	\$1,329.00

Shallow Tall Storage Unit

- (1) RH or LH Door Operation
or
- (1) Set of Doors
- (3) Shelves on 71.81" tall
- (4) Shelves on 81.89" tall

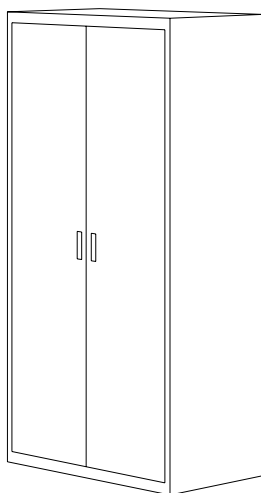

#S247224LH	23.63"	71.81"	23.63"	300lbs	\$1,149.00
#S247224RH	23.63"	71.81"	23.63"	300lbs	\$1,149.00
#S248224LH	23.63"	81.89"	23.63"	330lbs	\$1,249.00
#S248224RH	23.63"	81.89"	23.63"	330lbs	\$1,249.00
#S307224	29.53"	71.81"	23.63"	345lbs	\$1,299.00
#S308224	29.53"	81.89"	23.63"	365lbs	\$1,399.00
#S367224	35.43"	71.81"	23.63"	375lbs	\$1,449.00
#S368224	35.43"	81.89"	23.63"	400lbs	\$1,549.00

Deep Tall Storage Unit

- (1) RH or LH Door Operation
or
- (1) Set of Doors
- (3) Shelves on 71.81" tall
- (4) Shelves on 81.89" tall

Specialty Tall Storage Cabinets

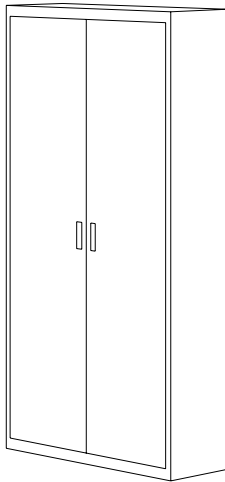

Part Number #	Width	Height	Depth	Weight	Price \$
---------------	-------	--------	-------	--------	----------

#SS245114LH	23.63"	50.39"	13.78"	250lbs	\$1,079.00
#SS245114RH	23.63"	50.39"	13.78"	250lbs	\$1,079.00
#SS247214LH	23.63"	71.81"	13.78"	260lbs	\$1,179.00
#SS247214RH	23.63"	71.81"	13.78"	260lbs	\$1,179.00
#SS248214LH	23.63"	81.89"	13.78"	270lbs	\$1,279.00
#SS248214RH	23.63"	81.89"	13.78"	270lbs	\$1,279.00
#SS305114	29.53"	50.39"	13.78"	275lbs	\$1,279.00
#SS307214	29.53"	71.81"	13.78"	290lbs	\$1,379.00
#SS308214	29.53"	81.89"	13.78"	305lbs	\$1,479.00
#SS365114	35.43"	50.39"	13.78"	300lbs	\$1,479.00
#SS367214	35.43"	71.81"	13.78"	320lbs	\$1,579.00
#SS368214	35.43"	81.89"	13.78"	340lbs	\$1,679.00

Shallow Shoe Storage Unit

- (1) RH or LH Door Operation
or
- (1) Set of Doors
- (6) Shelves on 50.39" tall
- (7) Shelves on 71.81" tall
- (8) Shelves on 81.89" tall

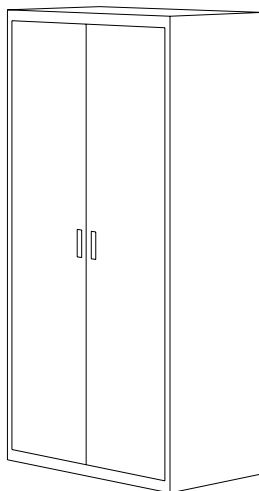

#CS245124LH	23.63"	50.39"	23.63"	320lbs	\$1,149.00
#CS245124RH	23.63"	50.39"	23.63"	320lbs	\$1,149.00
#CS247224LH	23.63"	71.81"	23.63"	335lbs	\$1,249.00
#CS247224RH	23.63"	71.81"	23.63"	335lbs	\$1,249.00
#CS248224LH	23.63"	81.89"	23.63"	350lbs	\$1,349.00
#CS248224RH	23.63"	81.89"	23.63"	350lbs	\$1,349.00
#CS305124	29.53"	50.39"	23.63"	355lbs	\$1,299.00
#CS307224	29.53"	71.81"	23.63"	370lbs	\$1,399.00
#CS308224	29.53"	81.89"	23.63"	385lbs	\$1,499.00
#CS365124	35.43"	50.39"	23.63"	380lbs	\$1,449.00
#CS367224	35.43"	71.81"	23.63"	400lbs	\$1,549.00
#CS368224	35.43"	81.89"	23.63"	420lbs	\$1,649.00

Closet Storage Unit

- (1) RH or LH Door Operation
or
- (1) Set of Doors
- (1) Clothes Rod on 50.39" tall
- (1) Clothes Rod on 71.81" tall
- (2) Clothes Rods on 81.89" tall
- Back of Cabinet is Cedar-Lined

Specialty Tall Storage Cabinets

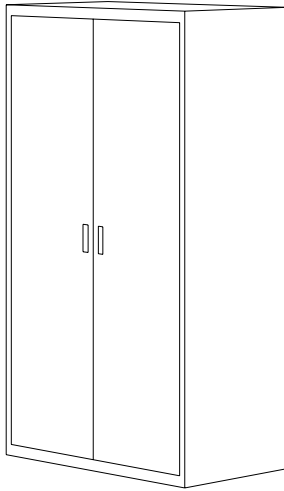

Part Number #	Width	Height	Depth	Weight	Price \$
---------------	-------	--------	-------	--------	----------

SKE248214LH	23.63"	81.89"	13.78"	290lbs	\$1,149.00
SKE248214RH	23.63"	81.89"	13.78"	290lbs	\$1,149.00
SKE308214	29.53"	81.89"	13.78"	320lbs	\$1,299.00
SKE368214	35.43"	81.89"	13.78"	350lbs	\$1,449.00
#SKE248224LH	23.63"	81.89"	23.63"	320lbs	\$1,249.00
#SKE248224RH	23.63"	81.89"	23.63"	320lbs	\$1,249.00
#SKE308224	29.53"	81.89"	23.63"	350lbs	\$1,399.00
#SKE368224	35.43"	81.89"	23.63"	380lbs	\$1,549.00

Ski Storage Unit

(1) RH or LH Door Operation

or

(1) Set of Doors

Includes (2) Ski Brackets on 13.78" Deep

Includes (4) Ski Brackets on 23.63" Deep

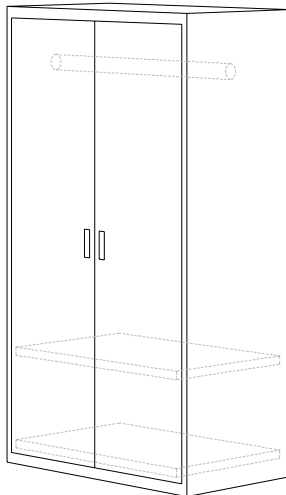

#CPS245124LH	23.63"	50.39"	23.63"	320lbs	\$1,129.00
#CPS245124RH	23.63"	50.39"	23.63"	320lbs	\$1,129.00
#CPS247224LH	23.63"	71.81"	23.63"	335lbs	\$1,229.00
#CPS247224RH	23.63"	71.81"	23.63"	335lbs	\$1,229.00
#CPS248224LH	23.63"	81.89"	23.63"	350lbs	\$1,329.00
#CPS248224RH	23.63"	81.89"	23.63"	350lbs	\$1,329.00
#CPS305124	29.53"	50.39"	23.63"	355lbs	\$1,279.00
#CPS307224	29.53"	71.81"	23.63"	370lbs	\$1,379.00
#CPS308224	29.53"	81.89"	23.63"	385lbs	\$1,479.00
#CPS365124	35.43"	50.39"	23.63"	380lbs	\$1,429.00
#CPS367224	35.43"	71.81"	23.63"	400lbs	\$1,529.00
#CPS368224	35.43"	81.89"	23.63"	420lbs	\$1,625.00

Closet/Pull-Out Shelf Storage (1)

RH or LH Door Operation

or

(1) Set of Doors

(1) Rod and (1) Pull-Out Shelf on 50.39" tall

(1) Rod and (1) Pull-Out Shelf on 71.81" tall

(1) Rod and (2) Pull-Out Shelves on 81.89" tall

Not Cedar-Lined

Ceiling Height Storage

Part Number #	Width	Height	Depth	Weight	Price \$
---------------	-------	--------	-------	--------	----------

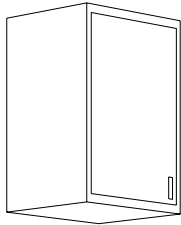

24" Wide/24" Deep Upper Unit

- (1) RH or LH Door Operation
- (1) Shelf on 26.46" & 31.50" tall
- (2) Shelves on 44.09" & 50.39" tall

#SU241924RH	23.63"	18.90"	23.63"	100lbs	\$479.00
#SU241924LH	23.63"	18.90"	23.63"	100lbs	\$479.00
#SU242424RH	23.63"	23.94"	23.63"	120lbs	\$529.00
#SU242424LH	23.63"	23.94"	23.63"	120lbs	\$529.00
#SU242724RH	23.63"	26.46"	23.63"	130lbs	\$579.00
#SU242724LH	23.63"	26.46"	23.63"	130lbs	\$579.00
#SU243224RH	23.63"	31.50"	23.63"	140lbs	\$629.00
#SU243224LH	23.63"	31.50"	23.63"	140lbs	\$629.00
#SU244524RH	23.63"	44.09"	23.63"	180lbs	\$729.00
#SU244524LH	23.63"	44.09"	23.63"	180lbs	\$729.00
#SU245124RH	23.63"	50.39"	23.63"	200lbs	\$829.00
#SU245124LH	23.63"	50.39"	23.63"	200lbs	\$829.00

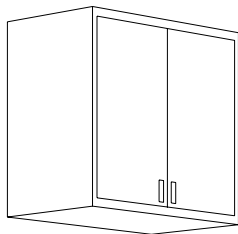

30" Wide/24" Deep Upper Unit

- (1) Set of Doors
- (1) Shelf on 26.46" 31.50" tall
- (2) Shelves on 44.09" & 50.39" tall

#SU301924	29.53"	18.90"	23.63"	125lbs	\$579.00
#SU302424	29.53"	23.94"	23.63"	140lbs	\$629.00
#SU302724	29.53"	26.46"	23.63"	150lbs	\$679.00
#SU303224	29.53"	31.50"	23.63"	160lbs	\$729.00
#SU304524	29.53"	44.09"	23.63"	205lbs	\$829.00
#SU305124	29.53"	50.39"	23.63"	220lbs	\$929.00

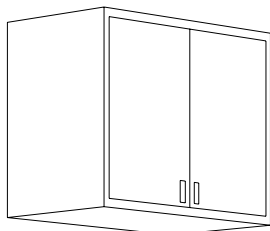

36" Wide/24" Deep Upper Unit

- (1) Set of Doors
- (1) Shelf on 26.46" 31.50" tall
- (2) Shelves on 44.09" & 50.39" tall

#SU361924	35.43"	18.90"	23.63"	150lbs	\$679.00
#SU362424	35.43"	23.94"	23.63"	160lbs	\$729.00
#SU362724	35.43"	26.46"	23.63"	170lbs	\$779.00
#SU363224	35.43"	31.50"	23.63"	180lbs	\$829.00
#SU364524	35.43"	44.09"	23.63"	230lbs	\$979.00
#SU365124	35.43"	50.39"	23.63"	260lbs	\$1,079.00

Standard Depth Kick Plate Bases

(Use with the 23.63" Depth Cabinets)



2" High Kick Plate Base

Includes (4) 2.00" Level Legs

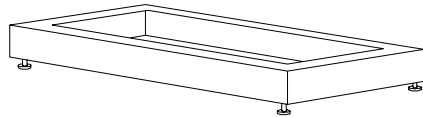

4" High Kick Plate Base

Includes (4) 4.00" Level Legs

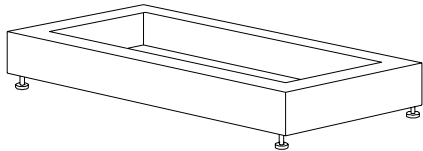

6" High Kick Plate Base

Includes (4) 4.00" Level Legs

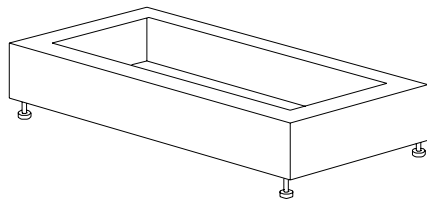

8" High Kick Plate Base

Includes (4) 4.00" Level Legs

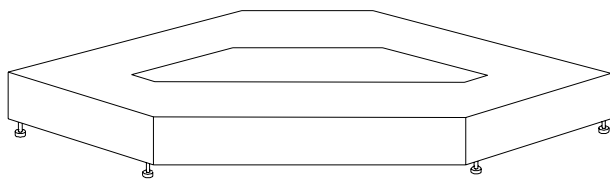

Corner Kick Plate Base

Includes (4) 4.00" Level Legs

Part Number #	Width	Height	Depth	Weight	Price \$
---------------	-------	--------	-------	--------	----------

#KP240224	23.63"	2.00"	18.00"	15lbs	\$89.00
#KP300224	29.53"	2.00"	18.00"	20lbs	\$99.00
#KP360224	35.43"	2.00"	18.00"	25lbs	\$109.00
#KP480224	47.23"	2.00"	18.00"	35lbs	\$119.00

#KP240424	23.63"	4.00"	18.00"	20lbs	\$99.00
#KP300424	29.53"	4.00"	18.00"	25lbs	\$109.00
#KP360424	35.43"	4.00"	18.00"	30lbs	\$119.00
#KP480424	47.23"	4.00"	18.00"	40lbs	\$129.00

#KP240624	23.63"	6.00"	18.00"	25lbs	\$109.00
#KP300624	29.53"	6.00"	18.00"	30lbs	\$119.00
#KP360624	35.43"	6.00"	18.00"	35lbs	\$129.00
#KP480624	47.23"	6.00"	18.00"	45lbs	\$139.00

#KP240824	23.63"	8.00"	18.00"	30lbs	\$119.00
#KP300824	29.53"	8.00"	18.00"	35lbs	\$129.00
#KP360824	35.43"	8.00"	18.00"	40lbs	\$139.00
#KP480824	47.23"	8.00"	18.00"	50lbs	\$149.00

#KPC480224	47.23"	2.00"	47.23"	50lbs	\$169.00
#KPC480424	47.23"	4.00"	47.23"	55lbs	\$179.00
#KPC480624	47.23"	6.00"	47.23"	60lbs	\$189.00
#KPC480824	47.23"	8.00"	47.23"	70lbs	\$199.00

Shallow Depth Kick Plate Bases

(Use with the 13.78" Depth Cabinets)



2" High Kick Plate Base

Includes (4) 2.00" Level Legs

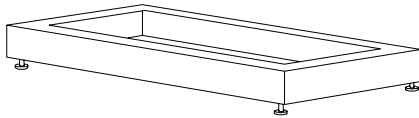

4" High Kick Plate Base

Includes (4) 4.00" Level Legs

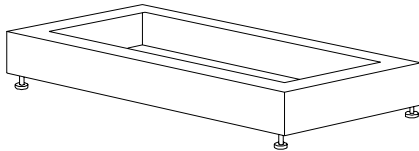

6" High Kick Plate Base

Includes (4) 4.00" Level Legs

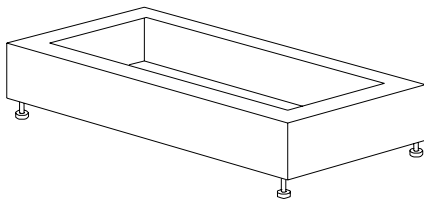

8" High Kick Plate Base

Includes (4) 4.00" Level Legs

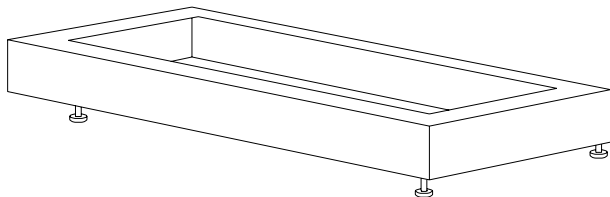

Corner Blind Kick Plate Base

Includes (4) 4.00" Level Legs

Part Number #	Width	Height	Depth	Weight	Price \$
---------------	-------	--------	-------	--------	----------

#KP240214	23.63"	2.00"	8.00"	10lbs	\$69.00
#KP300214	29.53"	2.00"	8.00"	12lbs	\$79.00
#KP360214	35.43"	2.00"	8.00"	15lbs	\$89.00
#KP480214	47.23"	2.00"	8.00"	20lbs	\$99.00

#KP240414	23.63"	4.00"	8.00"	15lbs	\$79.00
#KP300414	29.53"	4.00"	8.00"	18lbs	\$89.00
#KP360414	35.43"	4.00"	8.00"	20lbs	\$99.00
#KP480414	47.23"	4.00"	8.00"	25lbs	\$109.00

#KP240614	23.63"	6.00"	8.00"	20lbs	\$89.00
#KP300614	29.53"	6.00"	8.00"	23lbs	\$99.00
#KP360614	35.43"	6.00"	8.00"	25lbs	\$109.00
#KP480614	47.23"	6.00"	8.00"	30lbs	\$119.00

#KP240814	23.63"	8.00"	8.00"	25lbs	\$99.00
#KP300814	29.53"	8.00"	8.00"	28lbs	\$109.00
#KP360814	35.43"	8.00"	8.00"	30lbs	\$119.00
#KP480814	47.23"	8.00"	8.00"	35lbs	\$129.00

#KPCB480224	47.23"	2.00"	18.00"	35lbs	\$129.00
#KPCB480424	47.23"	4.00"	18.00"	40lbs	\$139.00
#KPCB480624	47.23"	6.00"	18.00"	45lbs	\$149.00
#KPCB480824	47.23"	8.00"	18.00"	50lbs	\$159.00

Workbench Top Options

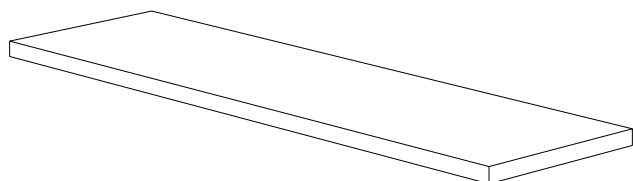

Maple Butcher Block

Wood Top

1.50" Thick Solid Maple

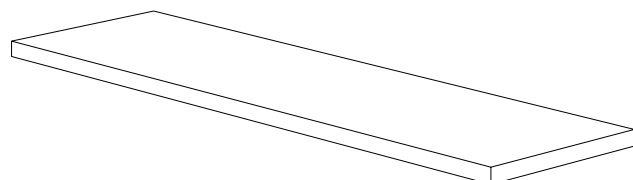

Galvanized Wrapped Top

16 GA. Galvanized Steel wrapped around
(2) 3/4" thick cabinet grade plywood

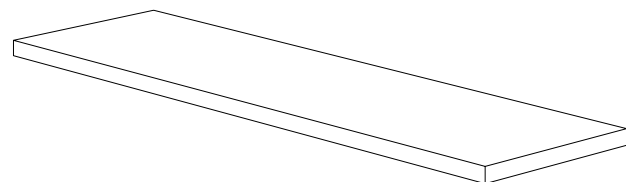

Stainless Steel Wrapped Top

16 GA. #4 Finish Stainless Steel wrapped around
(2) 3/4" thick finish grade plywood

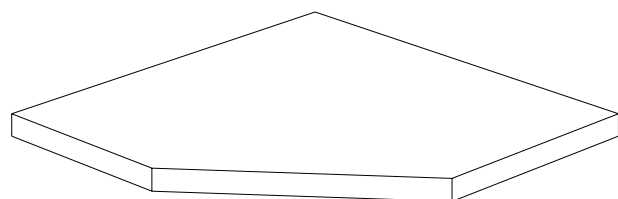

Corner Tops

Solid or with S.S Sink

Part Number #	Width	Height	Depth	Weight	Price \$
#TP2425BB	23.63"	1.50"	25.00"	40lbs	\$179.00
#TP3025BB	29.53"	1.50"	25.00"	45lbs	\$229.00
#TP3625BB	35.43"	1.50"	25.00"	50lbs	\$249.00
#TP4825BB	47.23"	1.50"	25.00"	60lbs	\$299.00
#TP6025BB	59.06"	1.50"	25.00"	70lbs	\$349.00
#TP7225BB	70.86"	1.50"	25.00"	80lbs	\$399.00
#TP8425BB	82.69"	1.50"	25.00"	90lbs	\$479.00
#TP9025BB	88.56"	1.50"	25.00"	100lbs	\$629.00
#TP9625BB	94.52"	1.50"	25.00"	135lbs	\$649.00
#TP10825BB	106.29"	1.50"	25.00"	160lbs	\$669.00
#TP12025BB	118.13"	1.50"	25.00"	175lbs	\$699.00
#TP13225BB	129.92"	1.50"	25.00"	185lbs	\$799.00
#TP14425BB	141.75"	1.50"	25.00"	200lbs	\$999.00

#TPW2425GV	23.63"	1.50"	25.00"	40lbs	\$99.00
#TPW3025GV	29.53"	1.50"	25.00"	45lbs	\$129.00
#TPW3625GV	35.43"	1.50"	25.00"	50lbs	\$159.00
#TPW4825GV	47.23"	1.50"	25.00"	60lbs	\$199.00
#TPW6025GV	59.06"	1.50"	25.00"	70lbs	\$249.00
#TPW7225GV	70.86"	1.50"	25.00"	80lbs	\$269.00
#TPW8425GV	82.69"	1.50"	25.00"	90lbs	\$289.00
#TPW9025GV	88.56"	1.50"	25.00"	100lbs	\$299.00
#TPW9625GV	94.52"	1.50"	25.00"	140lbs	\$329.00
#TPW10825GV	106.29"	1.50"	25.00"	160lbs	\$359.00

#TPW2425SS	23.63"	1.50"	25.00"	40lbs	\$249.00
#TPW3025SS	29.53"	1.50"	25.00"	45lbs	\$299.00
#TPW3625SS	35.43"	1.50"	25.00"	50lbs	\$349.00
#TPW4825SS	47.23"	1.50"	25.00"	60lbs	\$399.00
#TPW6025SS	59.06"	1.50"	25.00"	70lbs	\$449.00
#TPW7225SS	70.86"	1.50"	25.00"	80lbs	\$499.00
#TPW8425SS	82.69"	1.50"	25.00"	90lbs	\$599.00
#TPW9025SS	88.56"	1.50"	25.00"	100lbs	\$699.00
#TPW9625SS	94.52"	1.50"	25.00"	140lbs	\$749.00
#TPW10825SS	106.29"	1.50"	25.00"	160lbs	\$849.00

#TPCNR4825GV	47.23"	1.50"	47.23"	125lbs	\$899.00
#TPCNR4825BB	47.23"	1.50"	47.23"	135lbs	\$999.00
#TPCNR4825SS	47.23"	1.50"	47.23"	135lbs	\$1,099.00

#TPCNRSK4825GV	47.23"	1.50"	47.23"	145lbs	\$1,199.00
#TPCNRSK4825BB	47.23"	1.50"	47.23"	155lbs	\$1,299.00
#TPCNRSK4825SS	47.23"	1.50"	47.23"	155lbs	\$1,399.00

*#TPCNR4825BK				25lbs	\$229.00
---------------	--	--	--	-------	----------

*Order #TPCNR4825BK Bracket Kit
if using Corner Top without a cabinet below

Accessories

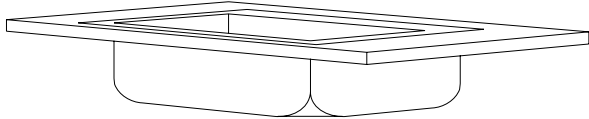

Stainless Steel Sink Top

1.50" Thick #4 Finish S.S Steel Top
Includes S.S. Sink Bowl 8" Deep

Part Number #	Width	Height	Depth	Weight	Price \$
---------------	-------	--------	-------	--------	----------

#TPWSK2425SS	23.63"	1.50"	25.00"	60lbs	\$449.00
#TPWSK3025SS	29.53"	1.50"	25.00"	65lbs	\$499.00
#TPWSK3625SS	35.43"	1.50"	25.00"	70lbs	\$549.00
#TPWSK4825SS	47.23"	1.50"	25.00"	80lbs	\$599.00
#TWPSK6025SS	59.06"	1.50"	25.00"	90lbs	\$649.00
#TPWSK7225SS	70.86"	1.50"	25.00"	100lbs	\$699.00
#TPWSK8425SS	82.69"	1.50"	25.00"	110lbs	\$799.00
#TPWSK9025SS	88.56"	1.50"	25.00"	120lbs	\$899.00
#TPWSK9625SS	94.52"	1.50"	25.00"	140lbs	\$949.00
#TPWSK10825SS	106.29"	1.50"	25.00"	150lbs	\$1,049.00

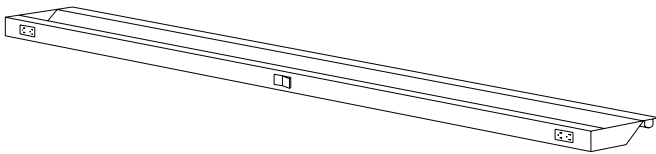

Light Bar with Plugs

Complete with Center Mounted ON/OFF Switch
and (2) Duplex Outlets

#LB36	35.43"	2.00"		25lbs	\$279.00
#LBCU36	32.75"	2.00"		25lbs	\$279.00
#LB48	47.23"	2.00"		30lbs	\$285.00
#LB60	59.06"	2.00"		40lbs	\$289.00
#LB72	70.86"	2.00"		45lbs	\$299.00
#LB84	82.69"	2.00"		50lbs	\$319.00
#LB90	88.56"	2.00"		55lbs	\$339.00
#LB96	94.52"	2.00"		60lbs	\$359.00
#LB108	106.29"	2.00"		65lbs	\$379.00

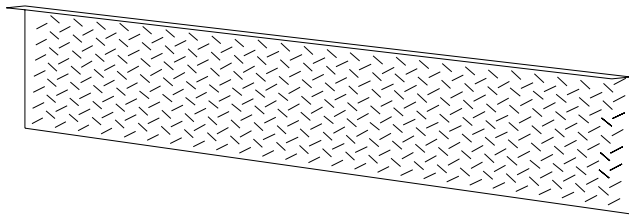

Diamond Aluminum Backsplash

16 GA. Thickness

#DA2418	23.63"	18.50"		4lbs	\$129.00
#DA3018	29.53"	18.50"		5lbs	\$139.00
#DA3618	35.43"	18.50"		6lbs	\$149.00
#DA4818	47.23"	18.50"		8lbs	\$179.00
#DA6018	59.06"	18.50"		10lbs	\$199.00
#DA7218	70.86"	18.50"		12lbs	\$229.00
#DA8418	82.69"	18.50"		14lbs	\$249.00
#DA9018	88.56"	18.50"		16lbs	\$269.00
#DA9618	94.52"	18.50"		18lbs	\$279.00
#DA10818	106.29"	18.50"		20lbs	\$299.00
#DA12018	118.13"	18.50"		25lbs	\$329.00

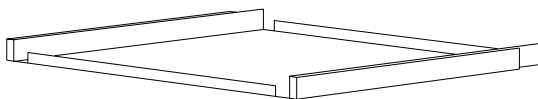

Pull-Out Shelf Option

150lb. Ball Bearing Slides

#POSF2424				20lbs	\$119.00
#POSF3024				25lbs	\$129.00
#POSF3624				30lbs	\$139.00

Rolling Tool Carts



Five Drawer Rolling Unit

Locking Drawers
 (2) Locking Swivel Castors
 (2) Rigid Castors
 Choice of Galvanized, Butcher Block or Stainless Steel Tops

Part Number #	Width	Height	Depth	Weight	Price \$
#LKR5D2432GV	23.63"	31.50"	23.63"	300lbs	\$1,629.00
#LKR5D2432BB	23.63"	31.50"	23.63"	300lbs	\$1,709.00
#LKR5D2432SS	23.63"	31.50"	23.63"	300lbs	\$1,779.00
#LKR5D3632GV	35.43"	31.50"	23.63"	375lbs	\$1,909.00
#LKR5D3632BB	35.43"	31.50"	23.63"	375lbs	\$1,989.00
#LKR5D3632SS	35.43"	31.50"	23.63"	375lbs	\$2,059.00

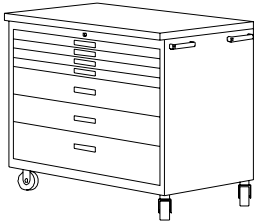

Seven Drawer Rolling Unit

Locking Drawers
 (2) Locking Swivel Castors
 (2) Rigid Castors
 Choice of Galvanized, Butcher Block or Stainless Steel Tops

#LKR7D2432GV	23.63"	38.50"	23.63"	325lbs	\$1,749.00
#LKR7D2432BB	23.63"	38.50"	23.63"	325lbs	\$1,829.00
#LKR7D2432SS	23.63"	38.50"	23.63"	325lbs	\$1,899.00
#LKR7D3632GV	35.43"	38.50"	23.63"	440lbs	\$2,029.00
#LKR7D3632BB	35.43"	38.50"	23.63"	400lbs	\$2,109.00
#LKR7D3632SS	35.43"	38.50"	23.63"	400lbs	\$2,179.00

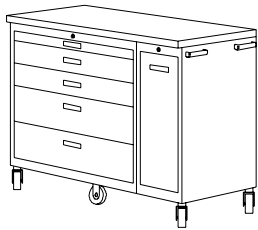

Five Drawer with Pull-Out Unit

Locking Drawers
 (2) Locking Swivel Castors
 (2) Rigid Castors
 Choice of Galvanized, Butcher Block or Stainless Steel Tops

#LKR5D2432PO1232GV	35.43"	38.50"	23.63"	425lbs	\$2,499.00
#LKR5D2432PO1232BB	35.43"	38.50"	23.63"	425lbs	\$2,589.00
#LKR5D2432PO1232SS	35.43"	38.50"	23.63"	425lbs	\$2,689.00
#LKR5D3632PO1232GV	47.23"	38.50"	23.63"	500lbs	\$2,809.00
#LKR5D3632PO1232BB	47.23"	38.50"	23.63"	500lbs	\$2,909.00
#LKR5D3632PO1232SS	47.23"	38.50"	23.63"	500lbs	\$3,009.00

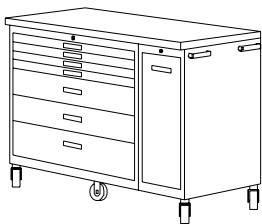

Seven Drawer with Pull-Out Unit

Locking Drawers
 (2) Locking Swivel Castors
 (2) Rigid Castors
 Choice of Galvanized, Butcher Block or Stainless Steel Tops

#LKR7D2432PO1232GV	35.43"	38.50"	23.63"	475lbs	\$2,619.00
#LKR7D2432PO1232BB	35.43"	38.50"	23.63"	475lbs	\$2,709.00
#LKR7D2432PO1232SS	35.43"	38.50"	23.63"	475lbs	\$2,809.00
#LKR7D3632PO1232GV	47.23"	38.50"	23.63"	550lbs	\$2,929.00
#LKR7D3632PO1232BB	47.23"	38.50"	23.63"	550lbs	\$3,029.00
#LKR7D3632PO1232SS	47.23"	38.50"	23.63"	550lbs	\$3,129.00